

ECE560

Computer and Information Security

Fall 2023

Reverse Engineering

Tyler Bletsch
Duke University

With additional content by Jiaming Li, NC State University, 2015

What is software reverse engineering?

- Determine and possibly change program logic
 - “Logic” ≠ Just observed behavior
- Ethics
 - Useful for good:
 - Analyze malware
 - Understand undocumented legacy code
 - Watch/read/play the stuff you paid for
 - Useful for evil
 - “Crack” software (remove restrictions)
 - Find exploits
 - Cheat at games

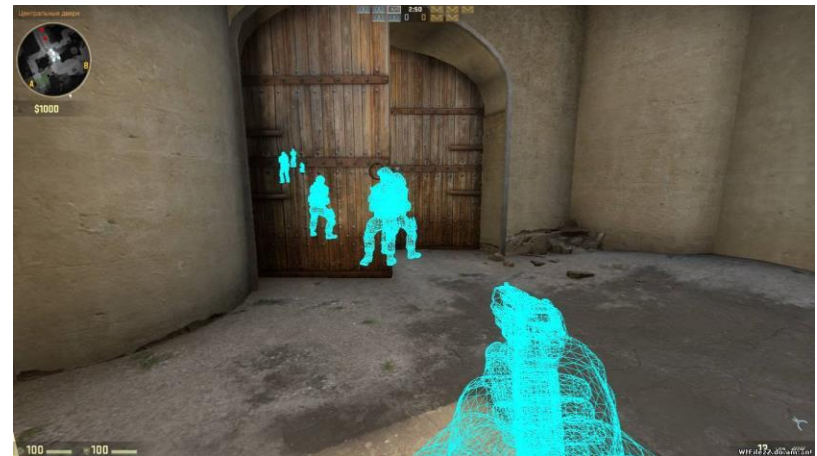

Types of tools

Static analysis

- **Disassembler**
 - Turn compiled program into assembly
 - Usually good, but can get confused: can't discern code from data if binary is weirdly laid out
- **Decompiler**
 - Attempts to turn assembly back into source code.
 - Usually awful at machine code, but managed code (e.g. Java, Python) can produce decent results.
- **Hex editor**
 - Understand binary data; make changes to binaries

Dynamic analysis

- **Debugger**
 - Step through running program
 - Very powerful: Gives control over time, order of execution, and content of data
 - Environment sometimes differs from regular execution in subtle ways ☹️
- **Monitoring tools**
 - Watch system calls, library calls, etc.

Examples of tools

- Linux:

- Disassembler: objdump (free), **IDA Pro** (free and paid versions), Ghidra (free, from NSA!)
- Debugger: **gdb** and its front-ends
- Hex editor: okteta, bless, lots more...
- Monitoring: **strace**, ltrace

IDA Pro eats basically anything



- Windows:

- Disassembler: **IDA Pro** (free and paid versions), Ghidra (free, from NSA!)
- Debugger: WinDBG (basic), **OllyDbg** (shareware), SoftICE (\$1000+)
- Hex editor: XVI32, Notepad++ with plugin, etc.
- Monitoring tools: Process Monitor, Explorer, and more.

- X86 in general: A hypervisor (VMware, KVM, etc.)

Debug or disassemble? Both.

- Disassembler gives **static** results
 - Good overview of program logic
 - But need to “mentally execute” program
 - Difficult to jump to specific functionality in the code
- Debugger is **dynamic**
 - Can set break points; fast forward to code for relevant functionality
 - Can treat complex code as “black box”
 - Not all code disassembles correctly
- Disassembler **and** debugger both required for any serious reverse engineering task

Example 1: HW2 auto-grader

- Python decompiles very easily

```
1 # Embedded file name: cryptotest.py
2 import subprocess
3 import sys, os
4 import zlib
5 import getpass
6 import socket
7 import datetime
8 import hashlib
9 from StringIO import StringIO
10 suppress_output = True
11 HEADER = 'cryptotest v1.1.0 by Dr. Tyler Bletsch (tkbletac@ncsu.edu)'
12 color_cmd = '33'
13 color_status = '32'
14 color_tests = '44;96'
15
16 def hash_self():
17     return hash_file(sys.argv[0])
18
19
20 def hash_file(filename):
21     with open(filename, 'rb') as fp:
22         m = hashlib.md5()
23         m.update(fp.read() + '\x0a' + '\x0a')
24         return m.hexdigest()
```



Example 2: Minecraft

- Minecraft is a Java program, no mod support
- All mods use something like the Mod Coder Pack (MCP):
 - “ Use MCP to decompile the Minecraft client and server jar files.
Use the decompiled source code to create mods for Minecraft.
Recompile modified versions of Minecraft.

Reobfuscate the classes of your mod for Minecraft.”
- Entire mod community is built on reverse engineering!



Examining multi-component systems

- Weaknesses often at the seams – where parts of system come together
 - Most visible, often exploitable
 - Example: SQL injection
- If not the seams, at least focus on the least protected part

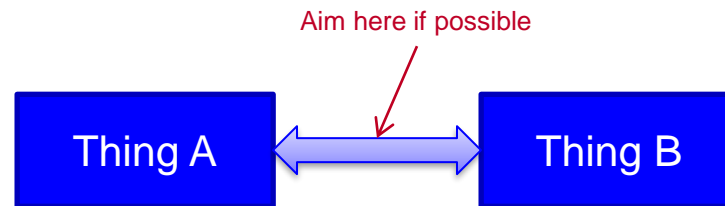

- Most common example: **user code** and **the kernel**
 - Known interface (system calls)
 - Inescapable – user code **MUST** use kernel to do stuff!

Example 3: reading strace

- You learn to see through the noise with practice

```
execve("./do_thing", [ "./do_thing" ], 0x7ffffdaa953d0 /* 28 vars */) = 0
brk(NULL) = 0x7ffffcd6a3000
arch_prctl(0x3001 /* ARCH_??? */, 0x7ffffd4efd730) = -1 EINVAL (Invalid argument)
access("/etc/ld.so.preload", R_OK) = -1 ENOENT (No such file or directory)
openat(AT_FDCWD, "/etc/ld.so.cache", O_RDONLY|O_CLOEXEC) = 3
fstat(3, {st_mode=S_IFREG|0644, st_size=47823, ...}) = 0
mmap(NULL, 47823, PROT_READ, MAP_PRIVATE, 3, 0) = 0x7fb596204000
close(3) = 0
openat(AT_FDCWD, "/lib/x86_64-linux-gnu/libc.so.6", O_RDONLY|O_CLOEXEC) = 3
read(3, "\177ELF\2\1\1\3\0\0\0\0\0\0\0\0\3\0>\0\1\0\0\0\360q\2\0\0\0\0"..., 832) = 832
pread64(3, "\6\0\0\0\4\0\0\0\0\0\0\0\0\0\0\0\0\0\0\0\0\0\0\0\0\0\0\0\0\0\0\0\0"..., 784, 64) = 784
pread64(3, "\4\0\0\0\20\0\0\0\5\0\0\0\0\0\2\0\0\300\4\0\0\0\3\0\0\0\0\0\0\0"..., 32, 848) = 32
pread64(3, "\4\0\0\0\24\0\0\0\3\0\0\0\0\0\233\222%\274\260\320\31\331\326\10\204\276X>\263"..., 68, 880) = 68
fstat(3, {st_mode=S_IFREG|0755, st_size=2029224, ...}) = 0
mmap(NULL, 8192, PROT_READ|PROT_WRITE, MAP_PRIVATE|MAP_ANONYMOUS, -1, 0) = 0x7fb596240000
pread64(3, "\6\0\0\0\4\0\0\0\0\0\0\0\0\0\0\0\0\0\0\0\0\0\0\0\0\0\0\0\0\0\0\0\0"..., 784, 64) = 784
pread64(3, "\4\0\0\0\20\0\0\0\5\0\0\0\0\0\2\0\0\300\4\0\0\0\3\0\0\0\0\0\0\0"..., 32, 848) = 32
pread64(3, "\4\0\0\0\24\0\0\0\3\0\0\0\0\0\233\222%\274\260\320\31\331\326\10\204\276X>\263"..., 68, 880) = 68
mmap(NULL, 2036952, PROT_READ, MAP_PRIVATE|MAP_DENYWRITE, 3, 0) = 0x7fb596010000
mprotect(0x7fb596035000, 1847296, PROT_NONE) = 0
mmap(0x7fb596035000, 1540096, PROT_READ|PROT_EXEC, MAP_PRIVATE|MAP_FIXED|MAP_DENYWRITE, 3, 0x25000) = 0x7fb596035000
mmap(0x7fb5961ad000, 303104, PROT_READ, MAP_PRIVATE|MAP_FIXED|MAP_DENYWRITE, 3, 0x19d000) = 0x7fb5961ad000
mmap(0x7fb5961f8000, 24576, PROT_READ|PROT_WRITE, MAP_PRIVATE|MAP_FIXED|MAP_DENYWRITE, 3, 0x1e7000) = 0x7fb5961f8000
mmap(0x7fb5961fe000, 13528, PROT_READ|PROT_WRITE, MAP_PRIVATE|MAP_FIXED|MAP_ANONYMOUS, -1, 0) = 0x7fb5961fe000
close(3) = 0
arch_prctl(ARCH_SET_FS, 0x7fb596241380) = 0
mprotect(0x7fb5961f8000, 12288, PROT_READ) = 0
mprotect(0x7fb596246000, 4096, PROT_READ) = 0
mprotect(0x7fb59623d000, 4096, PROT_READ) = 0
munmap(0x7fb596204000, 47823) = 0
brk(NULL) = 0x7ffffcd6a3000
brk(0x7ffffcd6c4000) = 0x7ffffcd6c4000
openat(AT_FDCWD, ".hidden_authorization_file", O_RDONLY) = -1 ENOENT (No such file or directory)
fstat(1, {st_mode=S_IFCHR|0660, st_rdev=makedev(0x4, 0x1), ...}) = 0
ioctl(1, TCGETS, {B38400 opost isig icanon echo ...}) = 0
write(1, "You are not authorized.\n", 24You are not authorized.
) = 24
exit_group(1) = ?
+++ exited with 1 +++
```

Boring stuff to start the program (load shared libraries, prepare heap)

Error message that we hate

Potentially relevant syscalls

Example 3: success

```
openat(AT_FDCWD, ".hidden_authorization_file", O_RDONLY) = -1 ENOENT (No such file or directory)
```

- It appears to check for a file called “.hidden_authorization_file” and doesn’t find it
- What if it *did* find it? Let’s try:

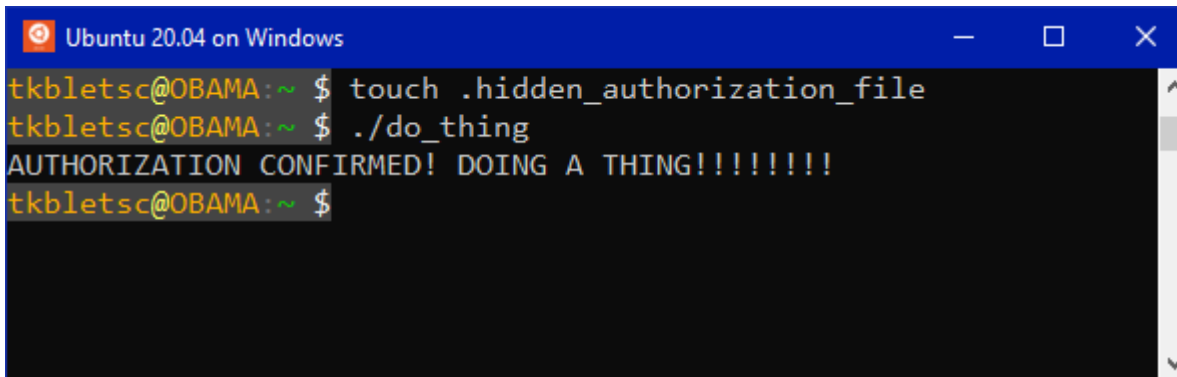
A terminal window titled "Ubuntu 20.04 on Windows" with standard window controls. The terminal shows the following commands and output:

```
tkblets@OBAMA:~$ touch .hidden_authorization_file
tkblets@OBAMA:~$ ./do_thing
AUTHORIZATION CONFIRMED! DOING A THING!!!!!!!
tkblets@OBAMA:~$
```

- Success!
- But what if the program actually looked inside the file and needed to see certain data in there?
 - Can’t see *computation* from here, just IO, so that’s when you use disassembler/debugger

Example 4:

NSA Codebreaker challenge, 2015

- Scenario:
 - Terrorists using a cryptography program to decrypt/authenticate messages from leadership
 - What we have:
 - The program: **codebreaker3.exe**
 - A member's key: **tier1_key.pem**
 - A text file with a hidden message: **tier1_msg.txt**
 - At first glance, the program appears to simply check stock information, but that's a ruse.
 - Need to reverse engineer it:
Challenge has 4 tasks, we'll do 2.

Codebreaker Task 1: Decrypt

- Need to decode message we have.
- The program:

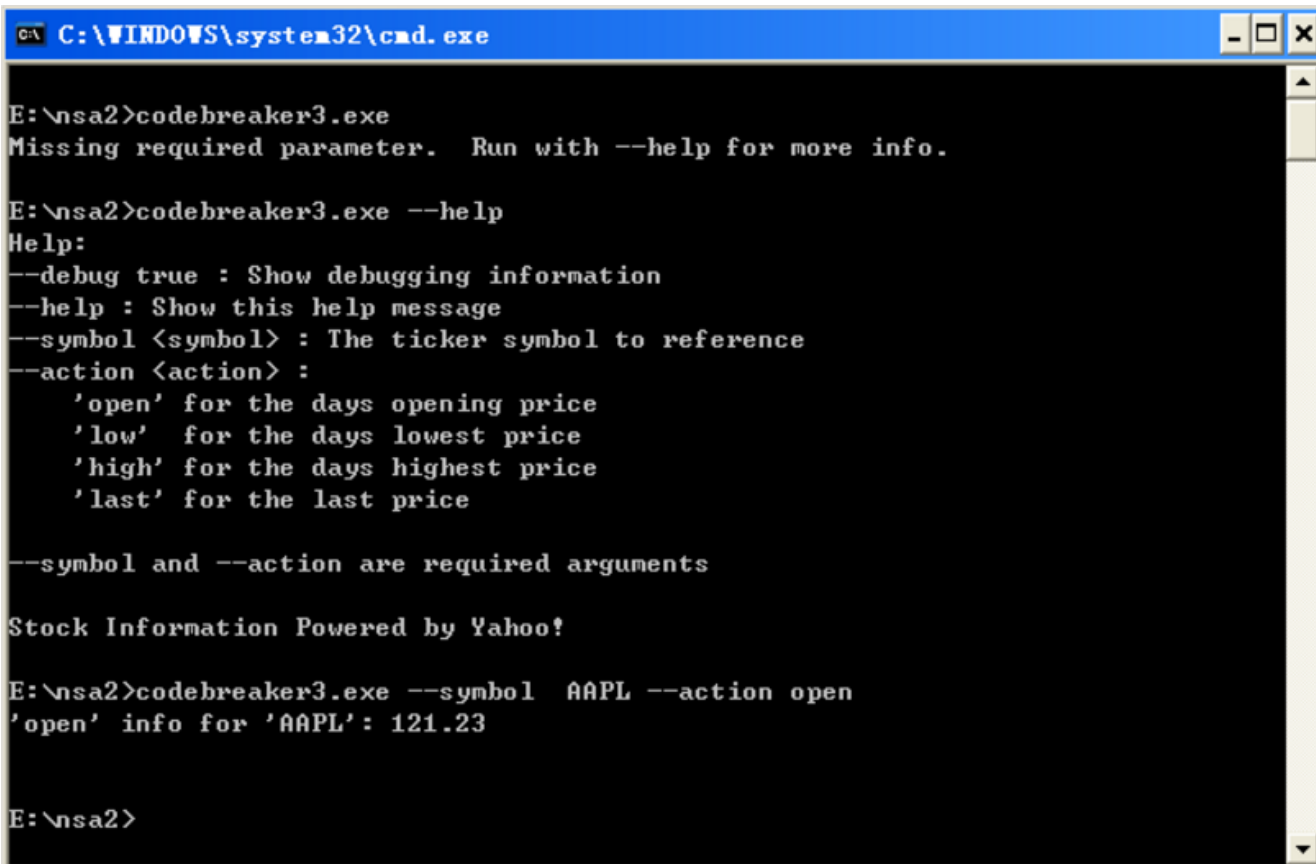

```
C:\WINDOWS\system32\cmd.exe

E:\nsa2>codebreaker3.exe
Missing required parameter.  Run with --help for more info.

E:\nsa2>codebreaker3.exe --help
Help:
--debug true : Show debugging information
--help : Show this help message
--symbol <symbol> : The ticker symbol to reference
--action <action> :
    'open' for the days opening price
    'low' for the days lowest price
    'high' for the days highest price
    'last' for the last price

--symbol and --action are required arguments

Stock Information Powered by Yahoo!

E:\nsa2>codebreaker3.exe --symbol AAPL --action open
'open' info for 'AAPL': 121.23

E:\nsa2>
```

Codebreaker Task 1: Decrypt

- Do static analysis with IDA Pro
 - Load binary
 - Confirm binary format options
 - Process:
 - Code is disassembled
 - Call graph of assembly code built
 - All memory references are cross-referenced, especially string literals

Codebreaker Task 1: Decrypt

- Do static analysis with IDA Pro, check the all string information

Address	Length	T...	String
"..." .rdata:0...	0000000F	C	Invalid action
"..." .rdata:0...	00000008	C	sprintf
"..." .rdata:0...	00000018	C	%"s" info for %"s": %s\n
"..." .rdata:0...	0000002E	C	Failed to pull finance data from symbol %"s"\n
"..." .rdata:0...	00000007	C	malloc
"..." .rdata:0...	00000019	C	Invalid (failed check 1)
"..." .rdata:0...	00000019	C	Invalid (failed check 2)
"..." .rdata:0...	00000019	C	Invalid (failed check 3)
"..." .rdata:0...	00000019	C	Invalid (failed check 4)
"..." .rdata:0...	00000019	C	Invalid (failed check 5)
"..." .rdata:0...	00000012	C	SHA256_Init error
"..." .rdata:0...	00000014	C	SHA256_Update error
"..." .rdata:0...	00000013	C	SHA256_Final error
"..." .rdata:0...	0000001D	C	*****SIGNATURE IS VALID*****
"..." .rdata:0...	0000000D	C	Message: %s\n
"..." .rdata:0...	00000019	C	Invalid (failed check 6)
"..." .rdata:0...	0000001F	C	!!!!SIGNATURE IS INVALID!!!!
"..." .rdata:0...	00000026	C	--decoder : Enter secret message mode
"..." .rdata:0...	00000015	C	secret-messenger.exe
"..." .rdata:0...	00000012	C	Debugging enabled
"..." .rdata:0...	00000019	C	Failed binary name check
"..." .rdata:0...	00000006	C	Help:
"..." .rdata:0...	0000002A	C	--debug true : Show debugging information
"..." .rdata:0...	00000020	C	--help : Show this help message
"..." .rdata:0...	00000033	C	--symbol <symbol> : The ticker symbol to reference
"..." .rdata:0...	00000015	C	--action <action> :
"..." .rdata:0...	00000026	C	'open' for the days opening price
"..." .rdata:0...	00000025	C	'low' for the days lowest price

Codebreaker Task 1: Decrypt

- Press x, this leads us to the location where this string appears:

```
mov [esp+4Ch+var_4C], offset aHighForTheDays ; " 'high' for the days highest price"
call puts
mov [esp+4Ch+var_4C], offset aLastForTheLast ; " 'last' for the last price"
call puts
mov [esp+4Ch+var_4C], offset aSymbolAndActio ; "\n--symbol and --action are required arg"...
call puts
mov [esp+4Ch+var_4C], offset aStockInformati ; "\nStock Information Powered by Yahoo!"
call puts
mov [esp+4Ch+var_4C], 0
call exit
```

```
loc_51B917: ; "--decoder : Enter secret message node"
mov [esp+4Ch+var_4C], offset aDecoderEnterSe
call puts
jmp loc_51B7DF
```

```
loc_51B7DF:
mov [esp+4Ch+var_28], 1
jmp loc_51B7DF
```

Graph overview

(2035, 18: E: sub_51B770+1AE

deleted.
deleted.
deleted.
deleted.

Codebreaker Task 1: Decrypt

- OK, let's try "decoder" parameter:

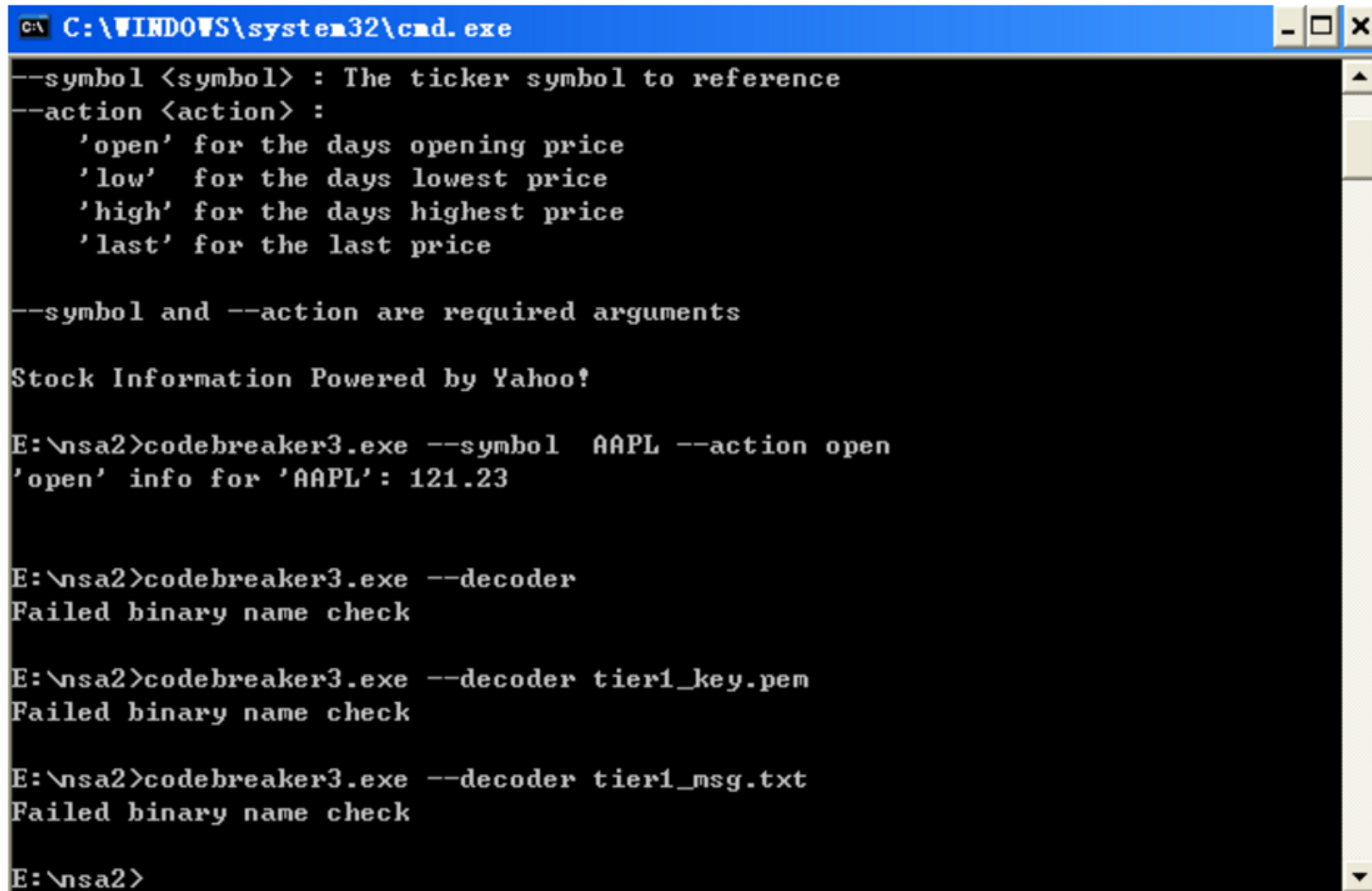

```
C:\WINDOWS\system32\cmd.exe
--symbol <symbol> : The ticker symbol to reference
--action <action> :
    'open' for the days opening price
    'low' for the days lowest price
    'high' for the days highest price
    'last' for the last price

--symbol and --action are required arguments

Stock Information Powered by Yahoo!

E:\nsa2>codebreaker3.exe --symbol AAPL --action open
'open' info for 'AAPL': 121.23

E:\nsa2>codebreaker3.exe --decoder
Failed binary name check

E:\nsa2>codebreaker3.exe --decoder tier1_key.pem
Failed binary name check

E:\nsa2>codebreaker3.exe --decoder tier1_msg.txt
Failed binary name check

E:\nsa2>
```

Codebreaker Task 1: Decrypt

- We need to find where “Failed binary name check” appears:

```
loc_51B9A6: ; "Failed binary name check"
mov     [esp+4Ch+var_4C], offset aFailedBinaryNa
call    puts
mov     [esp+4Ch+var_4C], 1
call    exit
```

- and this comes from:

```
loc_51B928:
mov     [esp+4Ch+var_44], 15h
mov     [esp+4Ch+var_48], edi
mov     [esp+4Ch+var_4C], offset aSecretMessenge ; "secret-messenger.exe"
call    memcmp
test    eax, eax
jnz     short loc_51B9A6
```

Codebreaker Task 1: Decrypt

- Then we change our program name to “secret-messenger.exe” and try again:

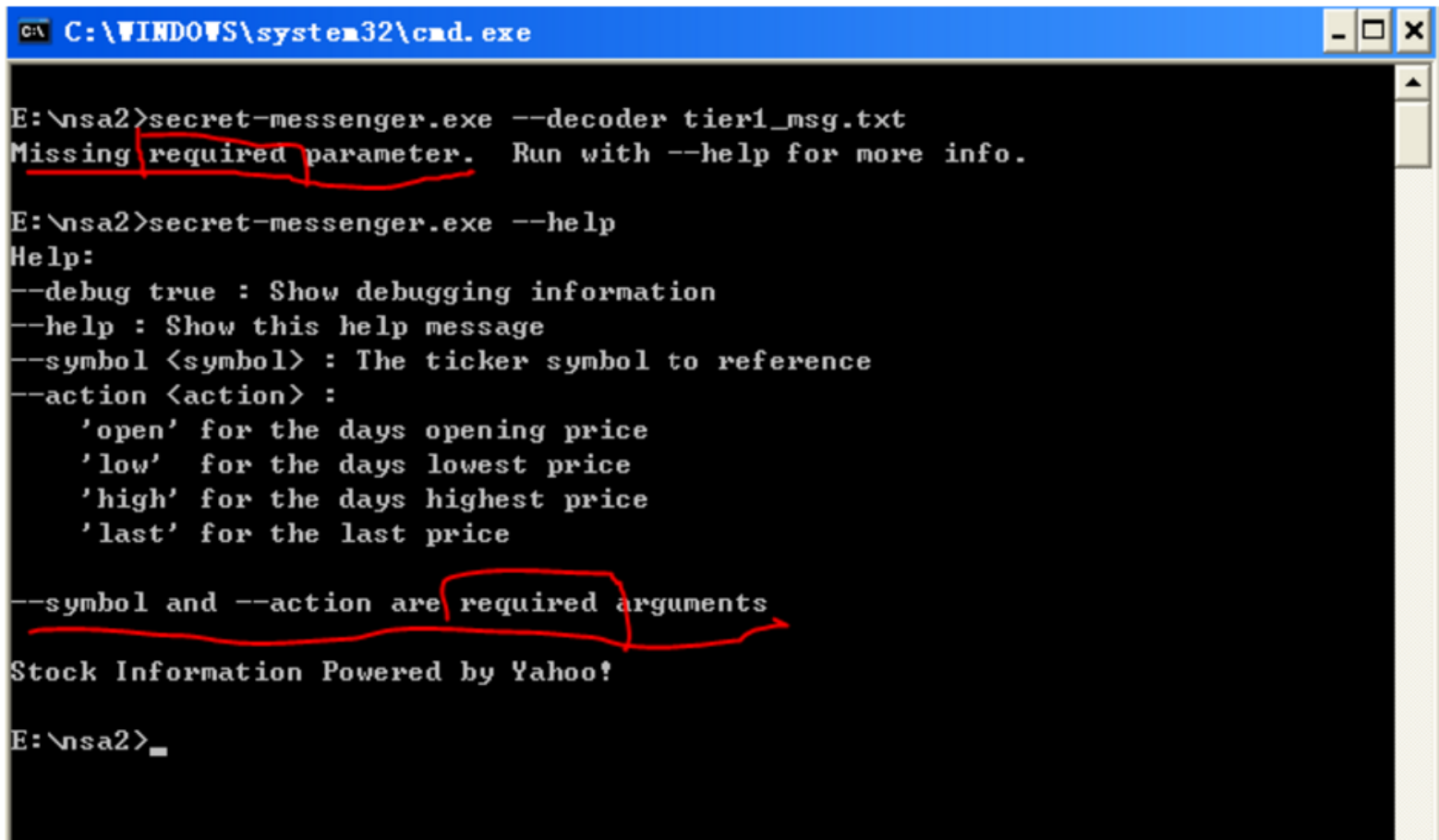

```
C:\WINDOWS\system32\cmd.exe

E:\nsa2>secret-messenger.exe --decoder tier1_msg.txt
Missing required parameter. Run with --help for more info.

E:\nsa2>secret-messenger.exe --help
Help:
--debug true : Show debugging information
--help : Show this help message
--symbol <symbol> : The ticker symbol to reference
--action <action> :
    'open' for the days opening price
    'low' for the days lowest price
    'high' for the days highest price
    'last' for the last price

--symbol and --action are required arguments

Stock Information Powered by Yahoo!

E:\nsa2>_
```

Codebreaker Task 1: Decrypt

- Ideas?
- Let's jam the stuff into symbol and action fields

```
E:\nsa2>secret-messenger.exe --symbol tier1_key.pem --action tier1_msg.txt --decoder
*****SIGNATURE IS VALID*****
Message: Meet at 22:00 tomorrow at our secure location. Come alone, and do not
tell anyone - this meeting is sensitive, as leadership will be present. To authenticate yourself, mention the pass code hpbl8rlmmhfkadi6nj8 at the door.
*****SIGNATURE IS VALID*****
E:\nsa2>
```



Codebreaker Task 2: Bypass access limitation

- We've collected a **new message file** - this one to a different field operative **whose key we also have**.
- Each operative has their own decrypt tool, each tool will only decrypt content "addressed" to its owner.
- Need to defeat this access limitation to decrypt the message.

```
E:\nsa2>secret-messenger.exe --symbol tier2_key.pem --action tier2_msg.txt --dec  
oder  
Invalid <failed check 4>  
E:\nsa2>
```

Codebreaker Task 2: Bypass access limitation

- Let's go back to IDA to find where this error appears:

Address	Length	T...	String
"..." .rdata:0...	0000000F	C	Invalid action
"..." .rdata:0...	00000008	C	sprintf
"..." .rdata:0...	00000018	C	'%s' info for '%s': %s\n
"..." .rdata:0...	0000002E	C	Failed to pull finance data from symbol '%s'\n
"..." .rdata:0...	00000007	C	malloc
"..." .rdata:0...	00000019	C	Invalid (failed check 1)
"..." .rdata:0...	00000019	C	Invalid (failed check 2)
"..." .rdata:0...	00000019	C	Invalid (failed check 3)
"..." .rdata:0...	00000019	C	Invalid (failed check 4)
"..." .rdata:0...	00000019	C	Invalid (failed check 5)



```
mov     [esp+10h+var_10], eax
call   edi ; ntohs
sub     esp, 4           ; netshort
cmp     ax, 4756h
jnz    loc_401ED3
```

```
movzx  eax, word ptr [ebx+1]
mov    [esp+10h+var_10], eax
call   edi ; ntohs
movzx  edx, ax
mov    eax, [ebp+var_2119C]
sub    esp, 4           ; void *
add    eax, 7
mov    [ebp+var_211B0], eax
add    eax, edx
cmp    eax, esi
jnz    loc_401F1B
```

```
loc_401ED3:           ; "Invalid (failed check 4)"
mov    [esp+10h+var_10], offset aInvalidfaile_0
call   puts
mov    [esp+10h+var_10], 1
call   exit
```

Codebreaker Task 2: Bypass access limitation

- Note down the address of “cmp ax,4756h”, press SPACE:

```
text:00401BE4
text:00401BE6
text:00401BEA
text:00401BED
text:00401BEF
text:00401BF2
text:00401BF6
text:00401BFC
text:00401C00
```

```
mov     [ecx], eax
movzx   eax, word ptr [ebx+5]
mov     [esp+10h+var_10], eax
call    edi ; ntohs
sub     esp, 4           ; netshort
cmp     ax, 4756h
jnz     loc_401ED3
movzx   eax, word ptr [ebx+1]
mov     [esp+10h+var_10], eax
```

- How to test if this is the check?
- How to bypass the check?

Codebreaker Task 2: Bypass access limitation

- In order to bypass this check as easily as possible, we can just modify the assembly code or change the specific flag during execution. Load the program with ollydbg:

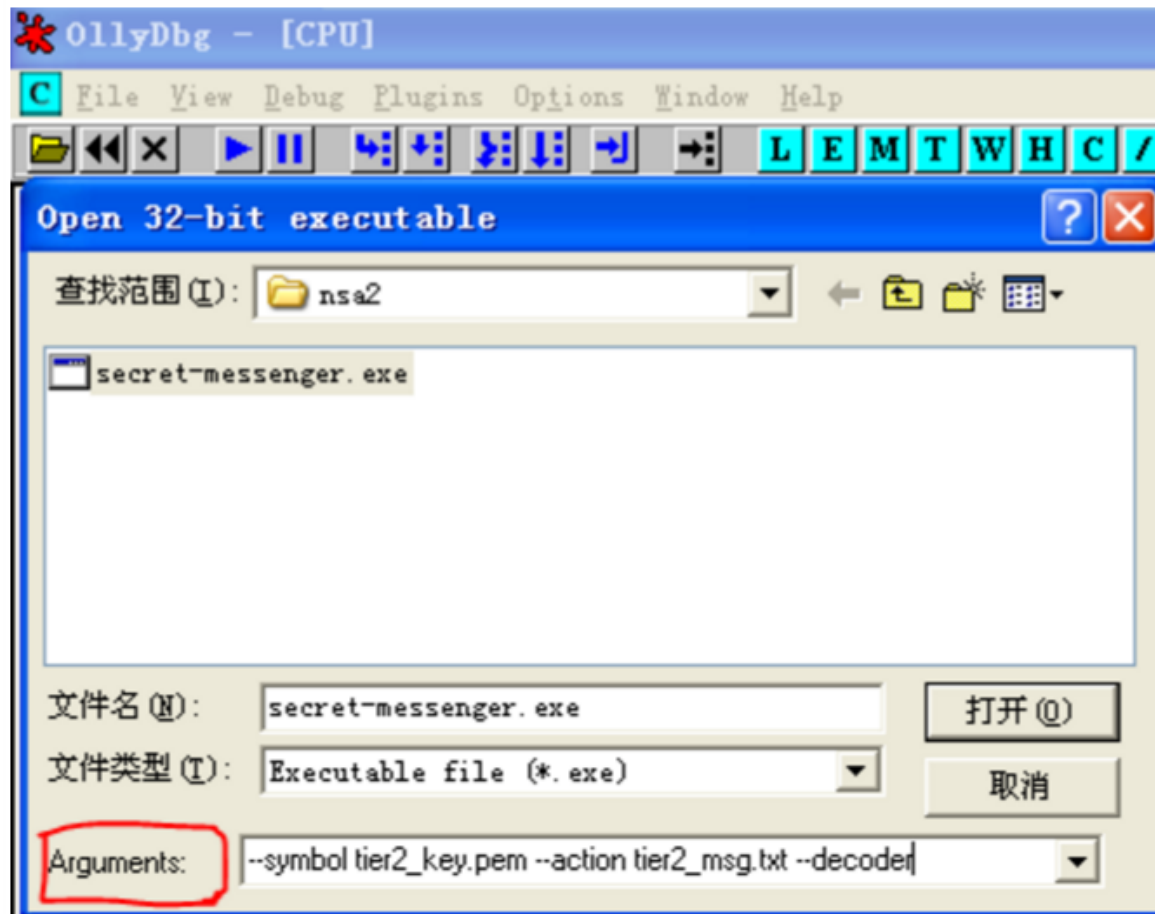

Codebreaker Task 2: Bypass access limitation

- Press CTRL+g go to the address 00401bf2, press F2 set breakpoint:

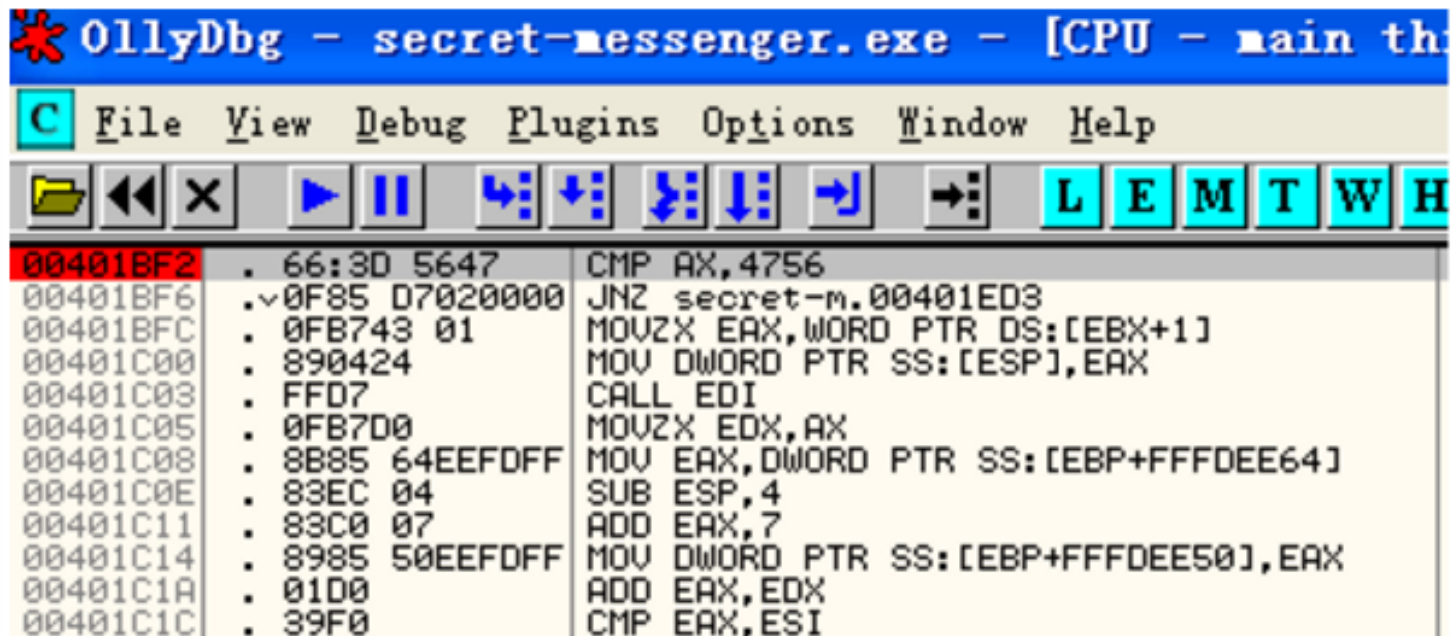

OllyDbg - secret-messenger.exe - [CPU - main th

File View Debug Plugins Options Window Help

⏪ ⏩ ⏸ ⏹ ⏴ ⏵ ⏶ ⏷ ⏸ ⏹ ⏴ ⏵ ⏶ ⏷ L E M T W H

00401BF2	. 66:3D 5647	CMP AX,4756
00401BF6	. 0F85 D7020000	JNZ secret-m.00401ED3
00401BFC	. 0FB743 01	MOVZX EAX,WORD PTR DS:[EBX+1]
00401C00	. 890424	MOV DWORD PTR SS:[ESP],EAX
00401C03	. FFD7	CALL EDI
00401C05	. 0FB7D0	MOVZX EDX,AX
00401C08	. 8B85 64EEFDFF	MOV EAX,DWORD PTR SS:[EBP+FFFDEE64]
00401C0E	. 83EC 04	SUB ESP,4
00401C11	. 83C0 07	ADD EAX,7
00401C14	. 8985 50EEFDFF	MOV DWORD PTR SS:[EBP+FFFDEE50],EAX
00401C1A	. 01D0	ADD EAX,EDX
00401C1C	. 39F0	CMP EAX,ESI

Codebreaker Task 2: Bypass access limitation

- Let's run the program and it will stop at this breakpoint, press F8 to run one more step and we modify the conditional JUMP instruction manually:

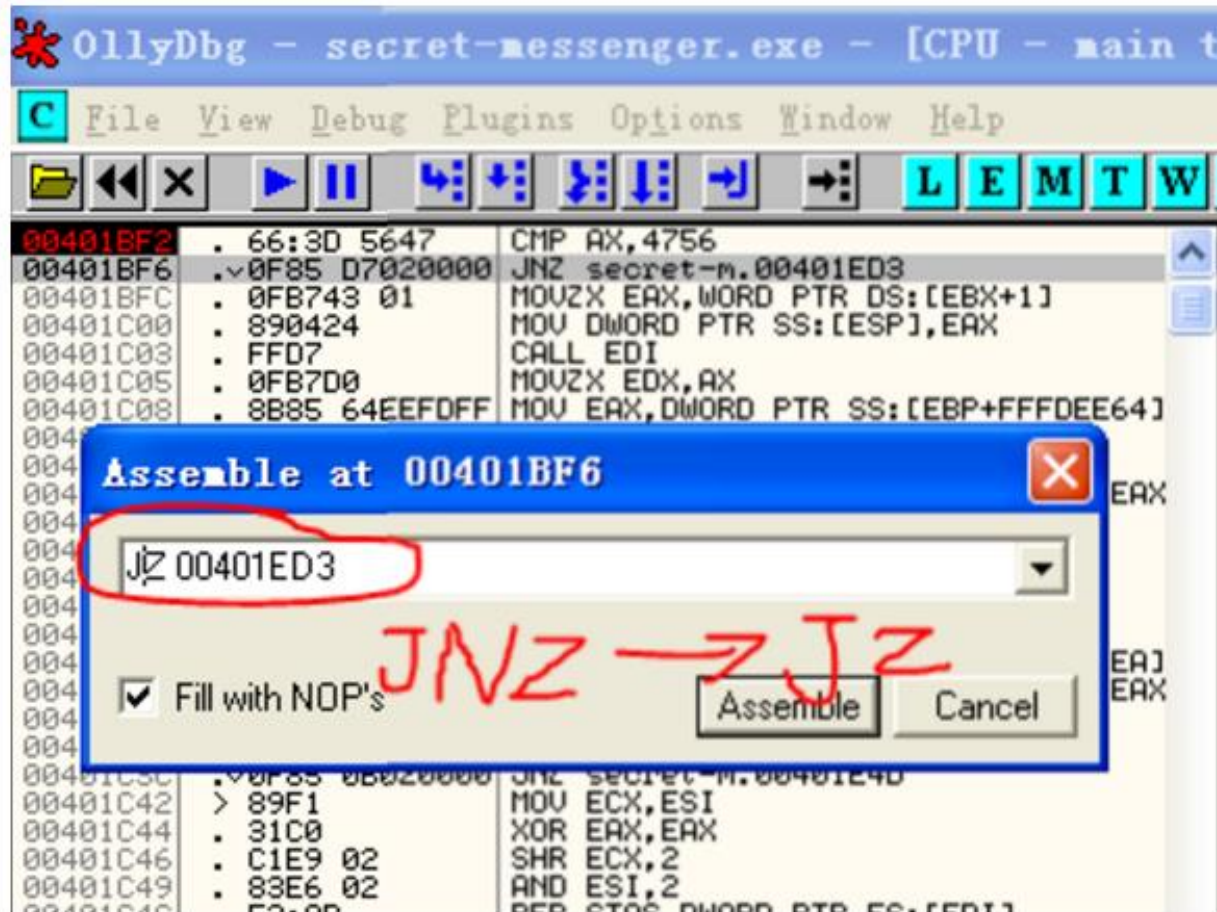

Codebreaker Task 2: Bypass access limitation

- Then, right click → copy to executable → all modification, so we just saved our new program, let's try to run it:

```
E:\nsa2\modified>secret-messenger.exe --symbol tier2_key.pem --action tier2_msg.txt --decoder
*****SIGNATURE IS VALID*****
Message: Our plans have been set into motion - Member number 392 is ready to carry out his tasking, and in 2 weeks time the window of opportunity will be open.
If it is necessary to abort the action, the authentication code to use is 43mohby6j8p7y32353mc.
*****SIGNATURE IS VALID*****
E:\nsa2\modified>
```



Anti-reverse engineering

- **Basics:**
 - Turn off debug symbols (omit -g)
 - Strip other symbols (e.g. “strip” tool on *NIX)
 - Consider static linking (no external calls to standard libraries to trace)
- **Anti-disassembly:**
 - Encrypted or self-modifying code
 - Code riddled with junk that is jumped over
 - Can especially confuse x86 assemblers due to variable-length instructions
- **Anti-debugging:**
 - Identify if debugger is in use (effects on real time, use of debug registers, etc.) and act differently
 - Use threads in complex ways to get less deterministic behavior
- **Tamper resistance:**
 - Hash parts of own code/data and verify periodically
 - The verification code is also code, though...
- **Obfuscation:**
 - Include lots of unreachable code to increase work the reverse engineer must do

DRM: Digital Rights Management

- Attempt to restrict what users can do with *data they have on a computer they own*
- Almost every implementation looks like this:

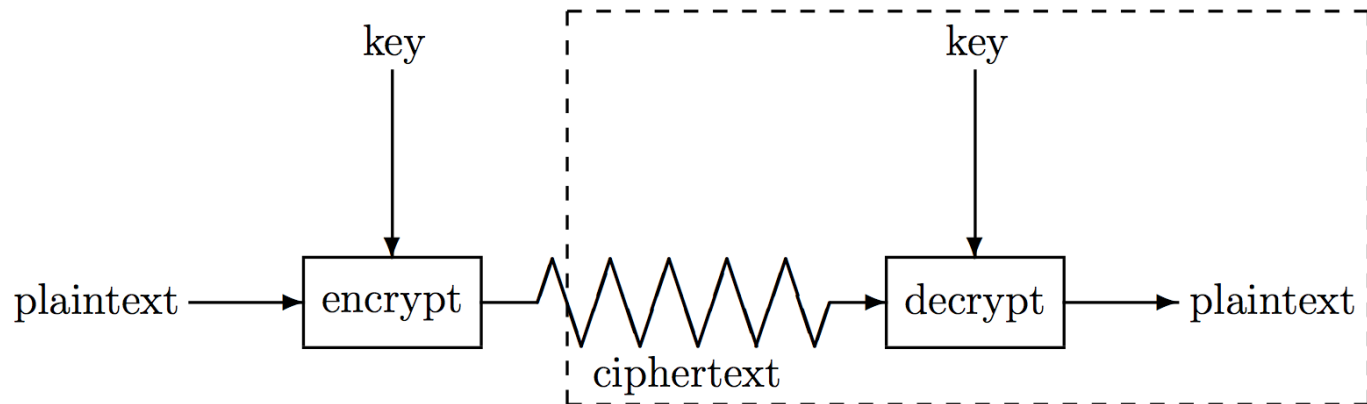

- Customer gets everything in the dashed box
- Problem?

Extra content

Example 3: Auto-grader for a homework question you didn't get

- Naïve attack: Just change the script

```
-bash
GNU nano 2.0.9 File: sha-test.sh

echo -n "" > in_empty
do_test in_empty 'a69f73cca23a9ac5c8b567dc185a756e97c982164fe25859e0d1dcc1475c80a615b2123af1f5f94c11e3e9402c3a

echo -n "abc" > in_abc
do_test in_abc 'b751850b1a57168a5693cd924b6b096e08f621827444f70d884f5d0240d2712e10e116e9192af3c91a7ec57647e3

seq 1 100000 > in_nums
do_test in_nums 'fc2c7d064771a4a3ba90a2e0c11fa8f7f6f3220b00fac456da680dcfb506914026848a8a0b1ae5eaa3251faffdba

NUM_CORRECT=3 # < im cheating!!!
case "$NUM_CORRECT" in
  0) SCORE=0 ;;
  1) SCORE=3 ;;
  2) SCORE=6 ;;
  3) SCORE=15 ;;
  *) SCORE=-999 ;;
esac

echo "Score: $SCORE" | tee -a $OUTPUT_CERT

echo "Signing..."
echo -e "\nSignatures:" >> $OUTPUT_CERT
./hw3sign < $TARGET >> $OUTPUT_CERT
./hw3sign < $OUTPUT_CERT >> $OUTPUT_CERT
RETVAL=$?
if [ "$RETVAL" -ne 0 ] ; then
  echo -e "\n\nWARNING: Signature tampering has been detected!"
fi

[ line 57/76 (75%), col 34/34 (100%), char 1677/2100 (79%) ]
^G Get Help      ^O writeOut     ^R Read File    ^Y Prev Page    ^K Cut Text
^X Exit          ^J Justify      ^W where Is     ^V Next Page    ^U UnCut Text
```

Example 3: Lost HW autograder

- Naïve attack: Just change the script
 - Failed: **hw3sign** must be checking it somehow!

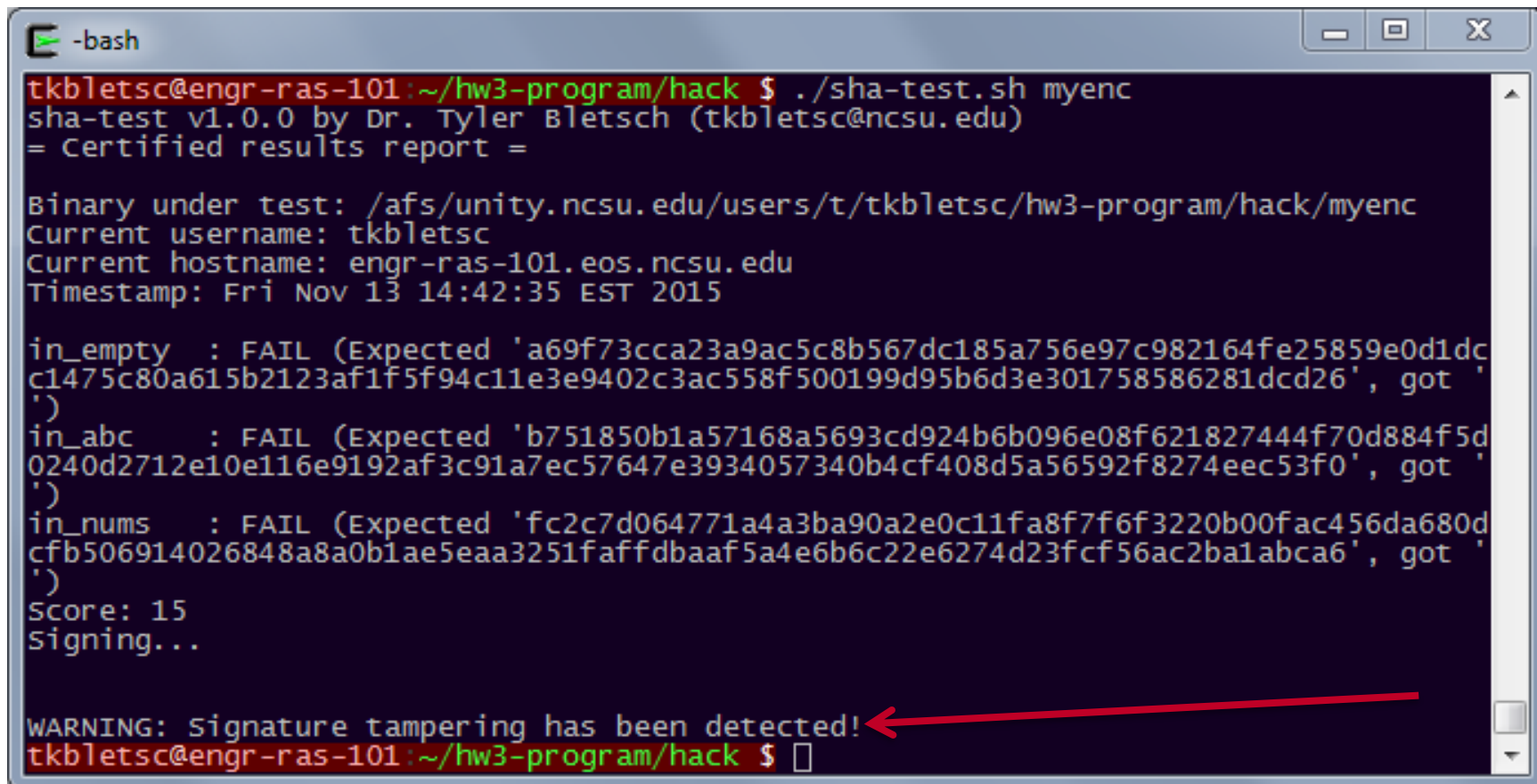

```
-bash
tkblets@engr-ras-101:~/hw3-program/hack $ ./sha-test.sh myenc
sha-test v1.0.0 by Dr. Tyler Bletsch (tkblets@ncsu.edu)
= Certified results report =

Binary under test: /afs/unity.ncsu.edu/users/t/tkblets/hw3-program/hack/myenc
Current username: tkblets
Current hostname: engr-ras-101.eos.ncsu.edu
Timestamp: Fri Nov 13 14:42:35 EST 2015

in_empty  : FAIL (Expected 'a69f73cca23a9ac5c8b567dc185a756e97c982164fe25859e0d1dc
c1475c80a615b2123af1f5f94c11e3e9402c3ac558f500199d95b6d3e301758586281dcd26', got '
')
in_abc    : FAIL (Expected 'b751850b1a57168a5693cd924b6b096e08f621827444f70d884f5d
0240d2712e10e116e9192af3c91a7ec57647e3934057340b4cf408d5a56592f8274eec53f0', got '
')
in_nums   : FAIL (Expected 'fc2c7d064771a4a3ba90a2e0c11fa8f7f6f3220b00fac456da680d
cfb506914026848a8a0b1ae5eaa3251faffdbaaf5a4e6b6c22e6274d23fcf56ac2ba1abca6', got '
')
Score: 15
Signing...

WARNING: Signature tampering has been detected!
tkblets@engr-ras-101:~/hw3-program/hack $
```

Example 3: Lost HW autograder Topology

hw3sign

sha-test.sh



Example 3: Lost HW autograder

- Could look at behavior with **strace**:

```
$ strace -f -o trace.txt ./sha-test.sh myenc
```

```
...
```

```
$ cat trace.txt
```

```
4127 execve("./sha-test.sh", ["/sha-test.sh", "myenc"], [/* 46 vars */]) = 0
```

```
4127 brk(0) = 0x1700000
```

```
4127 mmap(NULL, 4096, PROT_READ|PROT_WRITE, MAP_PRIVATE|MAP_ANONYMOUS, -1, 0) = 0x7f55d5a17000
```

```
4127 access("/etc/ld.so.preload", R_OK) = -1 ENOENT (No such file or directory)
```

```
4127 open("/etc/ld.so.cache", O_RDONLY) = 3
```

```
4127 fstat(3, {st_mode=S_IFREG|0644, st_size=210058, ...}) = 0
```

```
4127 mmap(NULL, 210058, PROT_READ, MAP_PRIVATE, 3, 0) = 0x7f55d59e3000
```

```
4127 close(3) = 0
```

```
...
```

- But `hw3sign` never appears to open `sha-test.sh`:

```
$ grep open trace.txt | grep sha-test.sh
```

```
4127 open("./sha-test.sh", O_RDONLY) = 3
```

- This one line is from when `sha-test.sh` itself is started
- There's more mystery here that I'll leave to you...

Example 3: Lost HW autograder

Best place to attack?

hw3sign

sha-test.sh

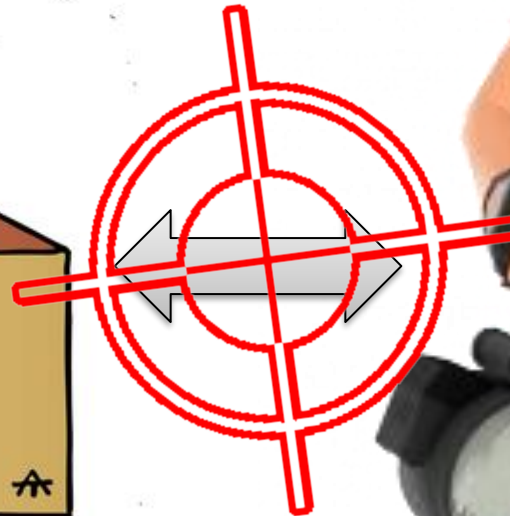

Example 3: Lost HW autograder

- Two past successful student attacks
- **Black box attack:**
 - hw3sign signs the binary, then the certificate itself
 - What if we ask it to “test” a doctored certificate as a binary – it will sign it for us! No understanding needed!
- **Chameleon attack:**
 - Add cheating to sha-test.sh; also add code to copy a legit sha-test.sh over itself before doing signings
 - Malicious behavior occurs then hides before check occurs
 - Example of a TOCTOU attack (Time-Of-Check/Time-Of-Use)!